

ELEKTRA BECKUM

Assembly/Operating Instructions Site Saw BKS 400/BKS 450

Model No. 1001

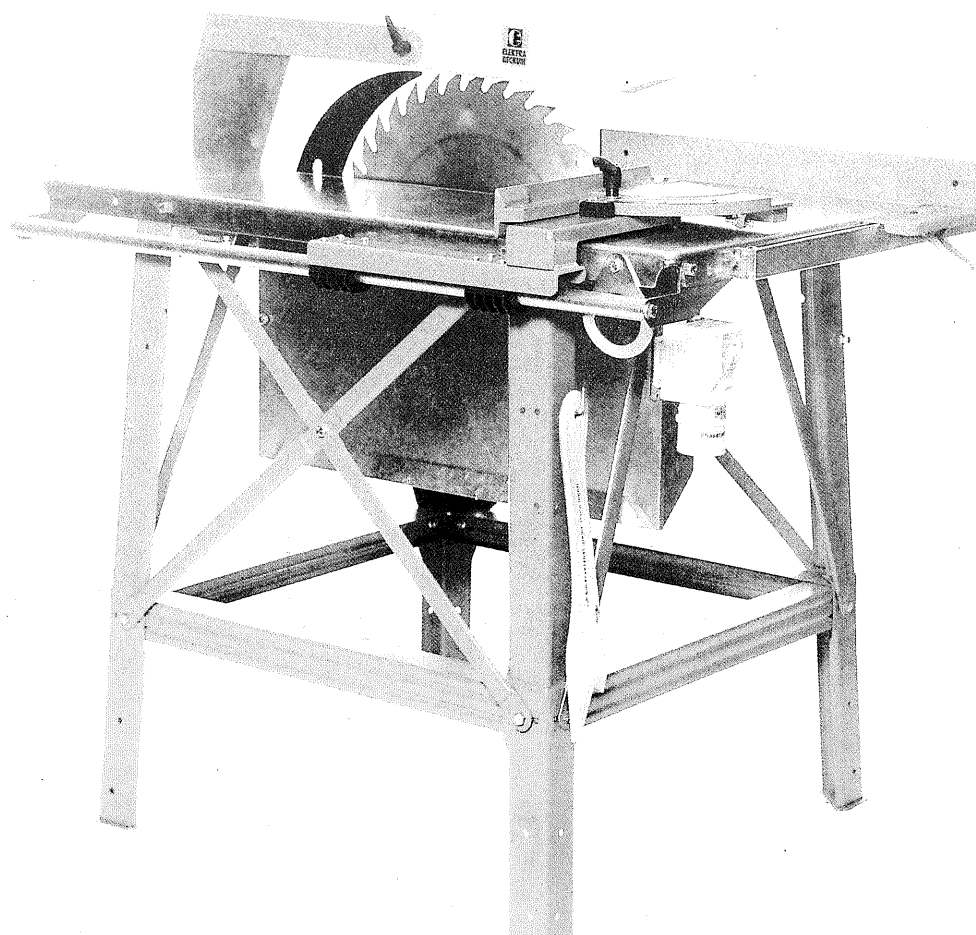

Contents

- 1.0 Scope of Application
- 2.0 Specifications
- 3.0 User Responsibility
- 4.0 Standard Accessories
- 5.0 Optional Accessories
- 6.0 Assembly
- 7.0 Mitre Fence Assembly
- 8.0 Installation
- 9.0 Operation/Settings
- 10.0 Cutting
- 11.0 Saw Dust Collection (optional accessory)
- 12.0 Crane Lifting
- 13.0 Safety Rules
- 14.0 Care and Maintenance
- 15.0 Wiring Diagrams
- 16.0 Spare Parts List and Drawing

1.0 Scope of Application

- This site saw model BKS 400/BKS 450 has been designed to perform rip and cross cuts in wood having a square or rectangular cross section.
- Cross cuts should only be performed with the help of the mitre fence.
- Round stock or firewood should not be cut without an appropriate jig holding the work safely.
- The maximum/minimum blade diameters are 400/350 mm for model BKS 400 and 450/350 mm for model BKS 450.

2.0 Specifications

	BKS 400/3.1 WNB	BKS400/4.2 DNB	BKS450/4.75DNB
Table size	1000 x 665 mm	1000 x 665 mm	1000 x 665 mm
Table height from floor	850 mm	850 mm	850 mm
Depth of cut	127 mm	127 mm	152 mm
Motor speed 50/60 Hz	2800/3360 rpm	2800/3360 rpm	2800/3360 rpm
Cutting speed	58.5 m/sec	58.5 m/sec	66 m/sec
Motor capacity P ₁ S6 40%	3.1 kW	4.2 kW	4,75 kW
Motor capacity P ₂ S1 100%	1.5 kW	2.1 kW	2.4 kW
Voltage	1~ 220/240V	3~ 380/440V	3~ 380/440V
Mains fuse	1 x 16A	3 x 16A	3 x 16A
Max. saw blade diameter	400 mm	400 mm	450 mm
Min. saw blade diameter	350 mm	350 mm	350 mm
Saw blade bore	30 mm dia.	30 mm dia.	30 mm dia.

Note: Saw blade 450mm diameter requires 4.75kW motor. Use of 450mm blades with 3.1kW and 4.2kW motor voids factory warranty!

3.0 User Responsibility

This machine will perform in conformity with the description contained in the instructions provided. This machine must be checked periodically. Defective equipment (including service leads) should not be used. Parts that are broken, missing, plainly worn, distorted or contaminated, should be replaced immediately. Should such repair or replacement become necessary, it is recommended that such repairs are carried out by qualified persons approved by the equipment manufacturer or its representative. This machine or any of its parts should not be altered or changed from standard specifications. The user of this machine shall have the sole responsibility for any malfunction which results from improper repair by anyone other than qualified persons approved by the equipment manufacturer or its representatives.

Note

Within the U.K., this machine falls under the Woodworking Machinery Regulations 1974, under which certain operations, e.g. grooving, rebating, tenoning and moulding are prohibited without special guards. For your own safety it is recommended to follow the instructions given in the Health and Safety at Work booklet No.41, entitled "Safety in the Use of Woodworking Machines" and "A Guide to Woodworking Machinery Regulations" HS(R)9. Both publications are available from Her Majesty's Stationary Office and other bookshops.

The information contained in this manual is intended to make the operator of this saw familiar with its safety features, setting of guards and fences, and the safe performance of the different basic cutting operations normally carried out with this type of saw. It does not teach the operator how to become an expert woodworker. Those persons interesting in gaining a more intimate knowledge on the tasks which can be carried out on this type of saw are advised to refer to commercially available literature on the subject.

4.0 Standard Accessories

- Saw blade
- Riving knife DIN 38820 Gr. 50x3
- Saw blade guard
- Rip fence
- Mitre fence
- Lifting eyes
- Push stick
- Tool set
- Operating instructions

5.0 Optional Accessories

For the ELEKTRA Site Saws BKS the following accessories are available at extra cost:

- Sliding Carriage BKS/BKH Stock-no. 0910 00666 5
- Extension Table BKS/BKH Stock-no. 0910 00667 3
- Dust Extraction Adaptor BKS 100mm Stock-no. 0910 00874 9
- Log Cutting Attachment BKS/BKH Stock-no. 0910 00886 2

6.0 Assembly

Place table onto firm support (e.g. saw horses).

Attach table insert (aluminium extrusion) to table; use 10 pcs. countersunk flat-head screw 4.2x13. Bolt rip fence guide extrusion to front of table.

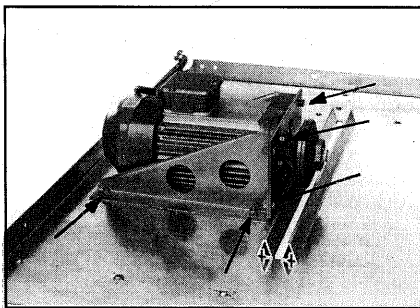

Bolt both support brackets to the motor. Use 4 each hex. head screw M8x16 hex. nut M8. Attach the thus preassembled motor to the table, but do not yet tighten fully. Use 4 each countersunk screw M8x16 hex.nut M8 washer 8.4

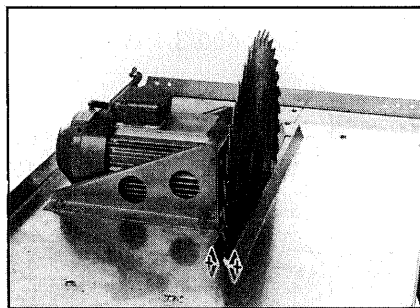

Install saw blade onto motor, then align motor so that the saw blade is centered in the table insert's slot. When positioned correctly fully tighten the motor on the table.

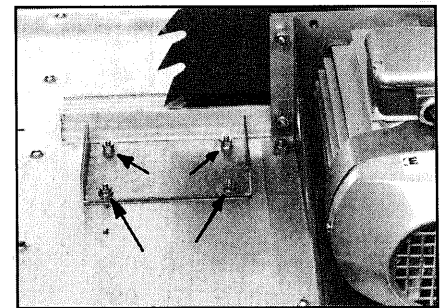

Attach mounting plate for the riving knife carrier bracket to the table. Use 4 each countersunk screw M6x16 hex. nut M6

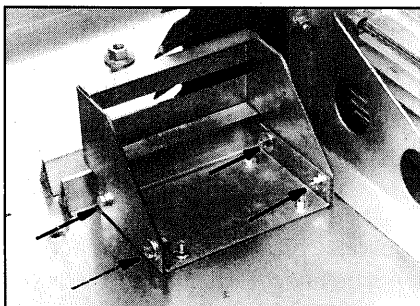

Attach riving knife carrier bracket loosely to mounting plate. Use 4 each hex. head screw M6x16 washer 6.4 hex. nut M6

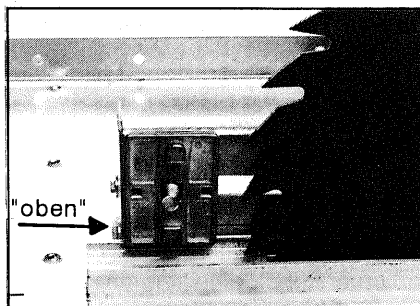

Place carriage bolt M12x30 into slot of carrier braand slide riving knife carrier onto bolt. The imprint "Oben" must point towards the table.

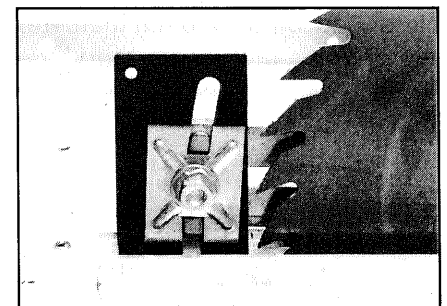

Mount riving knife and secure in place with pressure plate and self-locking hex. nut M12. Align riving knife with saw blade, then fully tighten the screws facing the riving knife carrier bracket to the mounting plate.

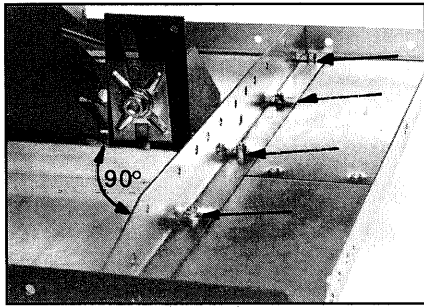

Place both support struts onto the table, set square with the slot of the table insert and bolt to the table. Use 10 each countersunk screw M6x16, hex. nut M6

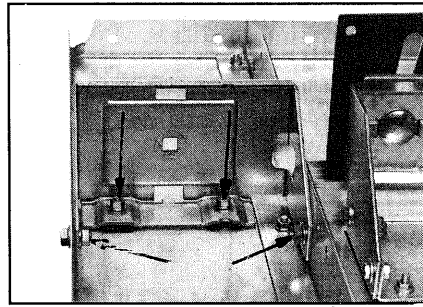

Install the guard support bracket without fully tightening the screws. Use 2 each countersunk screw M6x16, hex. nut M6, hex. head screw M8x16, hex. nut M8

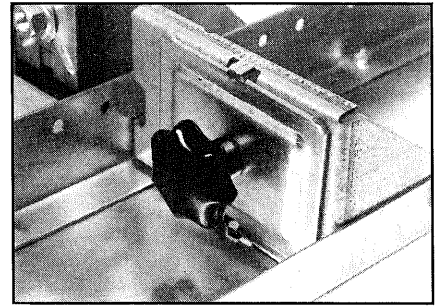

Attach gusset plate with carriage bolt M10x25, washer 10.5 and starknob M10

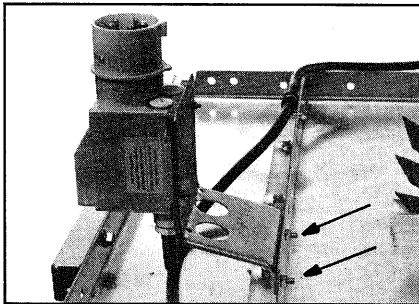

Bolt switch to front support strut. Use 2 each hex. head bolt M6x16 torque type hex. nut M6

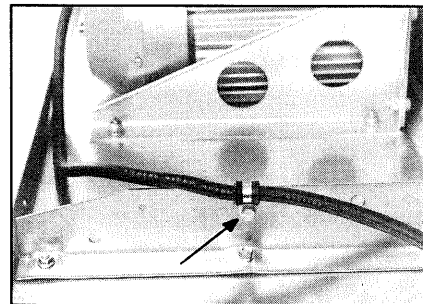

Attach strain relief clamp to support strut. Use hex. head bolt M6x16 hex. nut M6

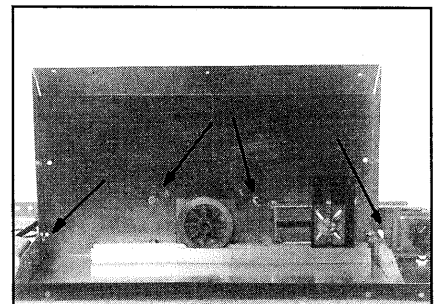

Remove saw blade and bolt chip case to both support struts and motor plate. Hardware: 4 ea. hex head screw M8x16 4 ea. hex. nut M8 2 ea. hex. head bolt M6x16 2 ea. washer 6.4 2 ea. hex. nut M6

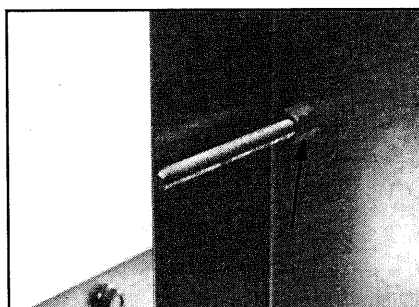

Install both hex. head bolts M8x90 into chipcase, secure with hex. nuts M8

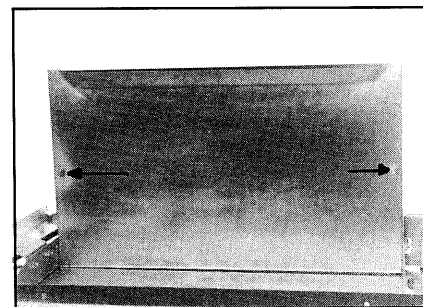

Re-install saw blade, be sure of correct direction of rotation. Install chip case lid. Use 2 each torque type hex. nut M8

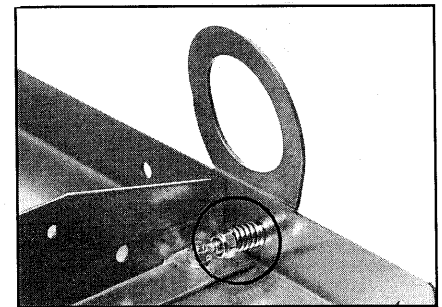

Bolt lifting eyes to table (at rear left and front right). Place pressure spring onto bolt before screwing on nut. Use 2 each hex. bolt M8x35 pressure spring 9x20 torque type hex. nut M8

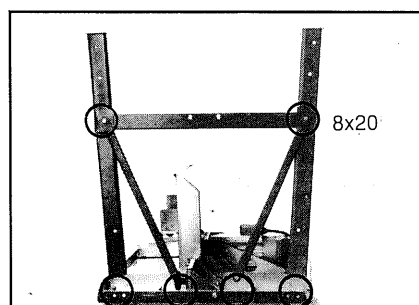

Install legs with struts and diagonal struts to table. - Tighten all screws handtight only at this stage. - Install struts as shown in drawing "A". Hardware: 22 each hex. head bolt M8x16; 4 each hex. head bolt M8x20; 26 each hex. nut M8

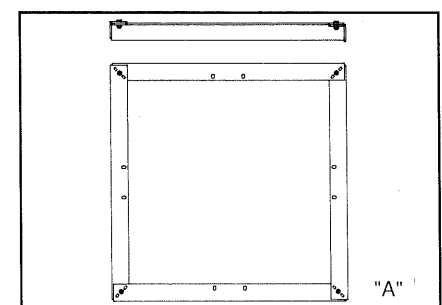
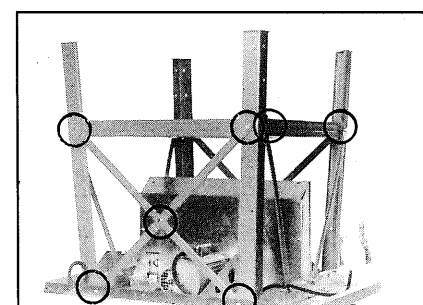

Turn saw over and stand onto its legs. Align and fully tighten all screws.

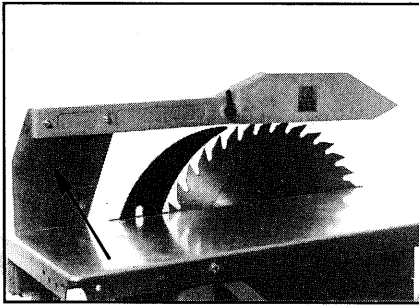

Place guard support into guard support bracket. Align with blade and riving knife and to exact 90 against the table by moving the not yet fully tightened guard support bracket. Tighten.

Note: An improperly set up guard support may cause personal injury to the operator.

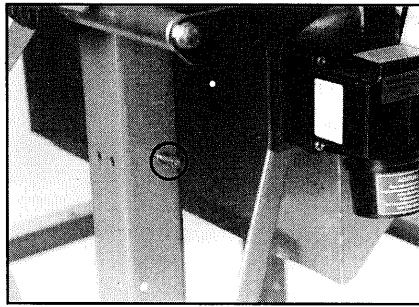

Install the hex. socket head screw holding the push stick to the front left leg. Hardware:
1 hex. socket head screw M6x30
2 each hex. nut M6

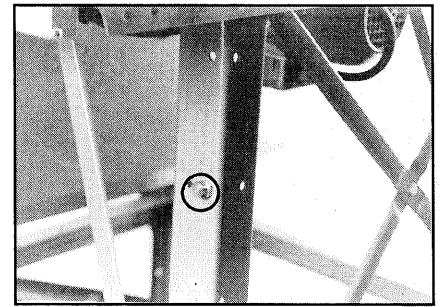

Install bolt for holding the rip fence to front right leg. Use hex. nut M8 and bolt M8

7.0 Mitre Fence Assembly

- Cross cuts and mitre cuts must not be carried out without a suitable cross-cutting attachment (sliding carriage or mitre fence).

If no mitre fence is installed use the Sliding Carriage stock-no. 091 000 06665.

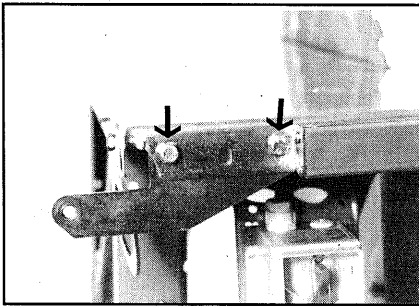

Bolt guide rod brackets to front and rear of table. Use 4 each hex. head bolt M8x16 hex. nut M8

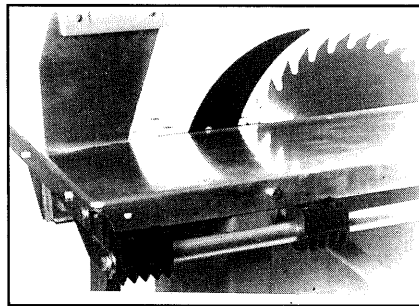

Slide both plastic guide bushes onto guide rod, then bolt guide rod to brackets. Use 2 hex. head bolts M8x20.

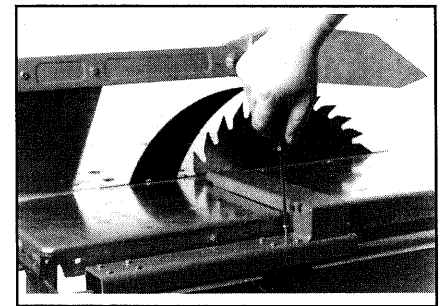

Bolt mitre fence carrier to guide bushes. Use 8 raised countersunk tapping screws 4.8x22.

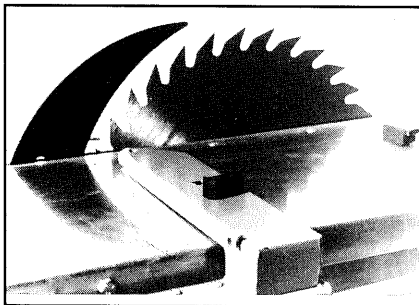

Screw vernier scale carrier to mitre fence carrier with raised countersunk head tapping screw 4.8x13

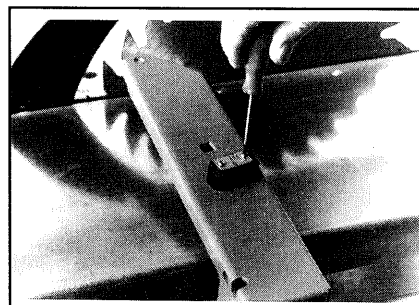

Screw vernier scale to vernier scale carrier with 2 each raised countersunk head tapping screw 2.9x6.5

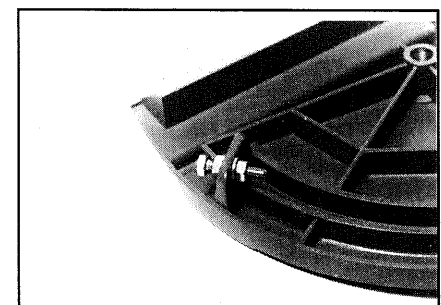

Install adjustable backstop on mitre fence segment. Hardware:
1 hex. head bolt M6x20
2 hex. nut M6
1 washer 6.4

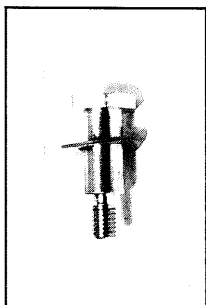

Place wave spring washer onto fitting bolt and plastic glide piece into mitre fence carrier.

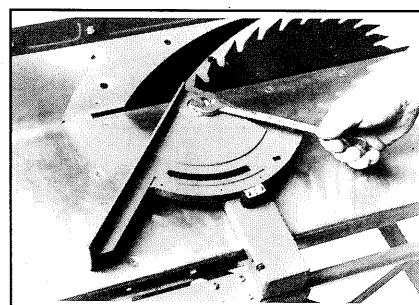
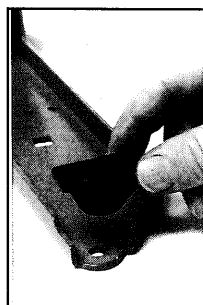

Place mitre fence segment onto carrier and screw fitting bolt through segment into glide piece.
Hardware:
fitting bolt SW 19x42
spring washer 12
plastic glide piece with threaded bush.

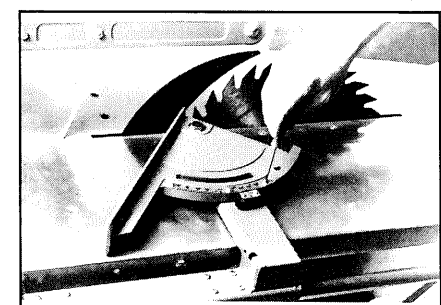

Attach mitre scale to segment using 3 each tapping screw 3.9x9.5 washer 4.3

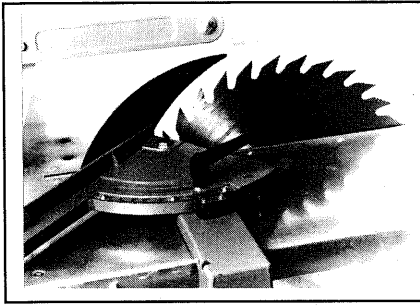

Place carriage bolt M10x30 from underneath through carrier and slot of fence segment. Install washer \varnothing 10.5 and ratched lever M10 female.

Install 0° (90°) setting screw into mitre fence carrier.

Hardware:
1 set screw M8x20
2 hex. thin nut M8

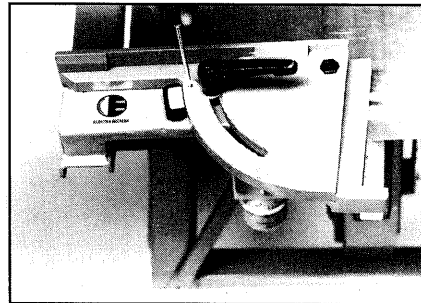
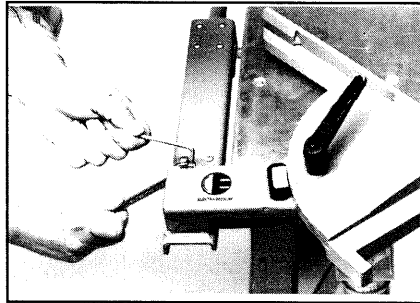
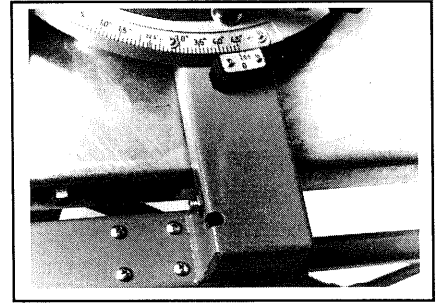

A
To set mitre fence square with the blade turn setting screw in or out, as required.

B
Make trial cut to verify setting.

C
Loosen mitre scale and adjust so that zero mark corresponds with mark on vernier scale, then retighten.

8.0 Installation

8.1 Setup

This saw must be placed on a firm and level ground. The work area must be kept clear of all waste to provide firm footing for the operator.

8.2 Connection to Power Mains

- Check if voltage of power mains matches with voltage stated on machine's name plate. This machine must be earthed while in use to protect the operator from electric shock.
- Models BKS400/3.1 kW must be connected to an earthed outlet with a 3-conductor mains lead.
- Models BKS 450/4.2 kW and 4.75 kW have to be connected to an earthed outlet with a 5-conductor mains lead.
- A minimum conductor cross section of 1.5mm²/16 AWG is required. For the 3.1kW single-phase motor extension cords should have a conductor cross section of 2.5mm².
- Use of an extension cord with too small a conductor cross section causes voltage drop and consequently starting problems and excessive heat build-up in the motor.

8.3 Saw Blade Direction of Rotation

- On single-phase machines the saw blade's direction of rotation does not need to be checked.
- For three-phase machines start saw briefly with all guards in place and check direction of rotation. If incorrect interchange two phases by rotating two pins in the switch by 180°. Remove plug, use screwdriver with 6mm/1/4" blade to push lock down and turn pins.
- To prevent unauthorized use the switch can be blocked with a padlock.

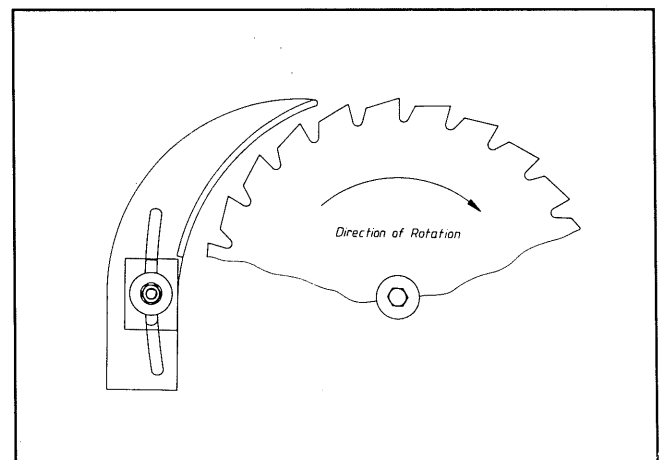

8.4 Switch/Motor Protection/Motor Brake

The magnetic switch does not engage if not connected to power mains. It disengages in the event of a power failure (no-volt release). When the power is restored the machine has to be started again.

The built-in motor protection relay switches the motor off in case it becomes too hot. If this has happened let motor cool down for at least 10 minutes before starting again. Three-phase motors are equipped with a mechanical brake, which is designed for a long service life. If the blade needs more than 10 sec. to come to a complete standstill the brake has to be replaced. Check with your ELEKTRA dealer for replacement.

An inoperative motor brake increases danger of injury!

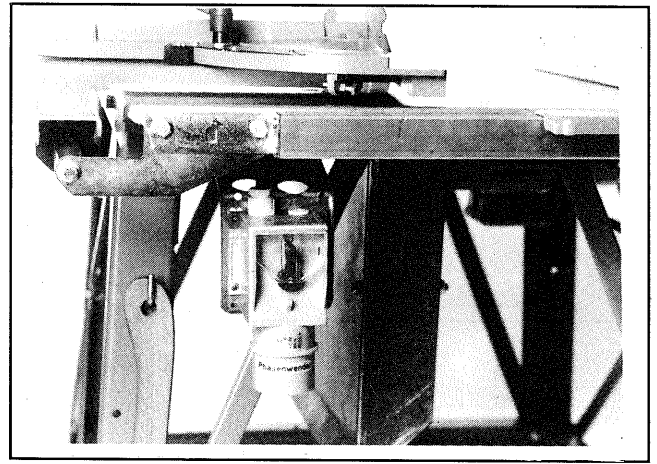

9.0 Operation/Settings

9.1 Riving Knife Setting

- Disconnect from power before servicing!

The riving knife prevents the work from closing behind the blade, thus stalling it and causing kickback.

Set riving knife as close as possible against the blade. The gap between riving knife and blade must not exceed 10mm/3/8 ". Do not set top of riving knife lower than 2mm-5/64" below the blade's crown.

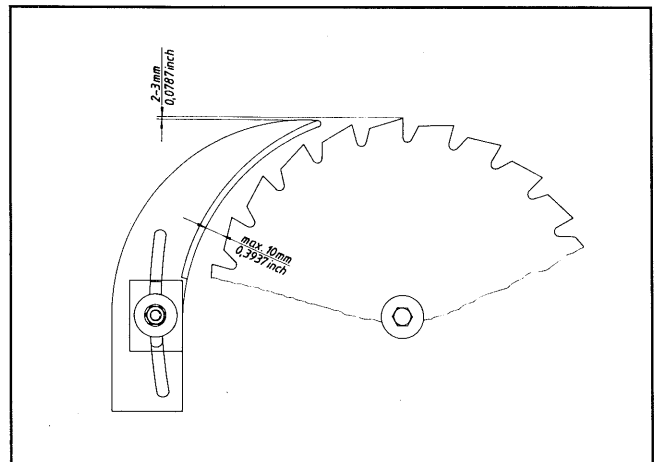
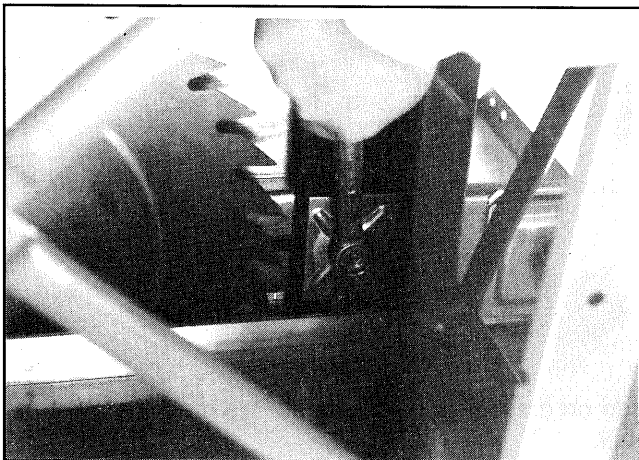

9.2 Blade Change

Disconnect from power before servicing!

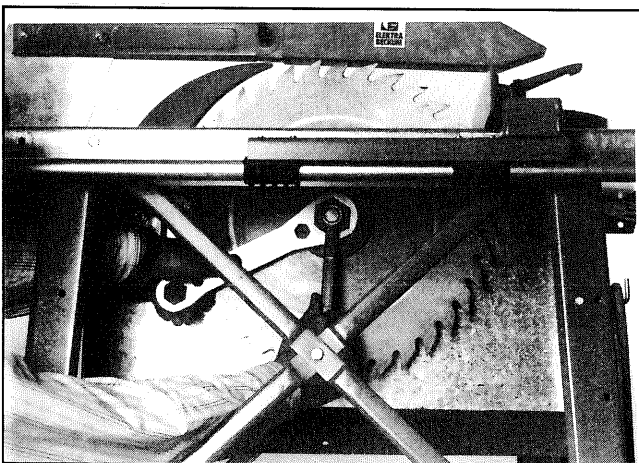

Remove chip case lid and loosen arbor bolt. Remove arbor bolt and counter flange, then take off blade.

Note: Arbor bolt has L.H. thread, turn clockwise to loosen.

Before installing new blade clean blade seat and apply a light coat of oil to the arbor bolt.

- Be sure that teeth are pointing in direction of rotation. Tighten arbor bolt carefully. Replace chip case lid and nuts securing it in place.

Operation without chip case lid in place may cause personal injury!

9.3 Rip Fence Setting/Adjusting

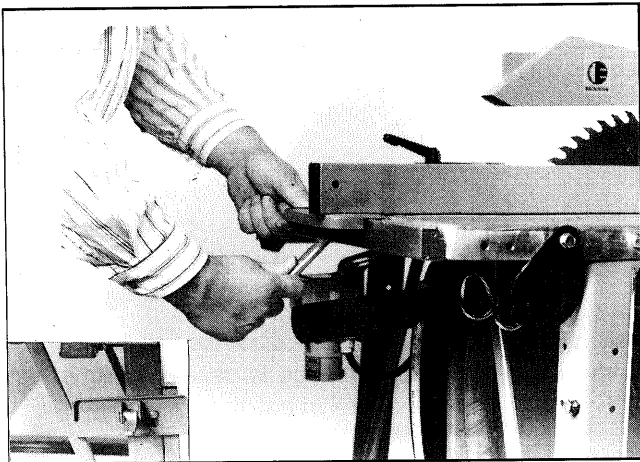

Set rip fence to required width of cut. Distance from blade is shown on the rip fence scale.

- Lock rip fence in position by pushing the cam-lock lever down.
- If rip fence is not required it can be hung to the bolt on the right leg.

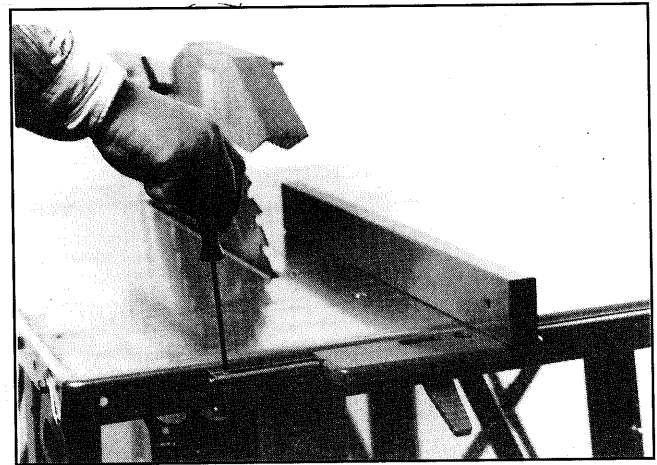

Loosen scale fixing screw to adjust rip fence scale to give exact reading of width of cut. Make trial cut to verify setting.

9.4 Saw Blade Guard

After loosening the starknob on the guard support bracket the complete guard assembly can be removed.

Risk of personal injury when saw is operated without blade guard in place!

Attention!

Remove/install blade guard only with blade at complete standstill.

Danger of injury!

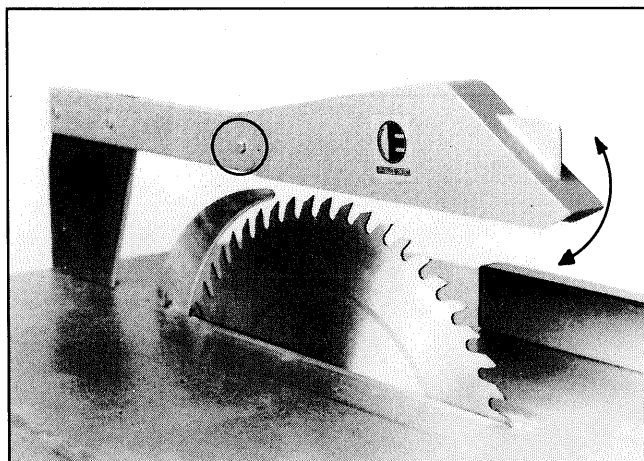
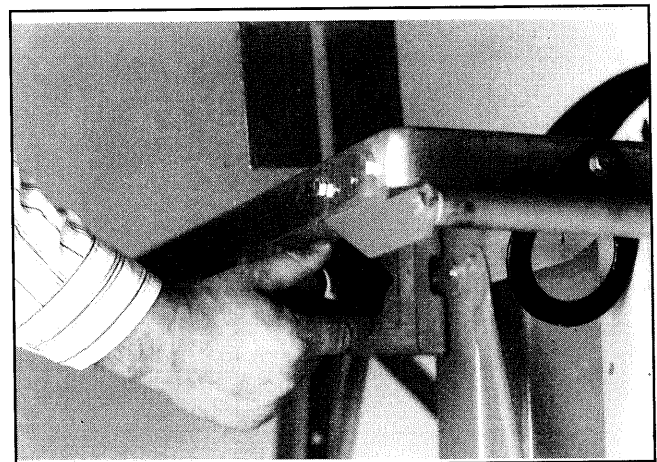

Loosen the ratched lever to adjust the blade guard position. Set blade guard about 8mm/3/8" higher than the work-piece's thickness.

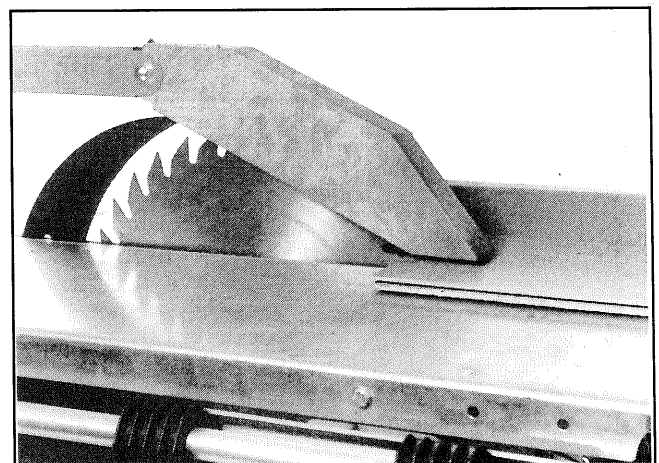

Attention! Set blade guard only with blade at complete standstill. **Danger of injury!**

10.1 Ripping/Through Sawing

10.0 Cutting

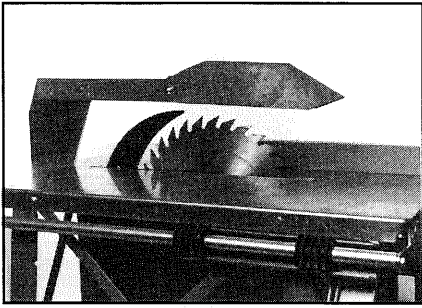

Have riving knife and blade guard in place - danger of injury.

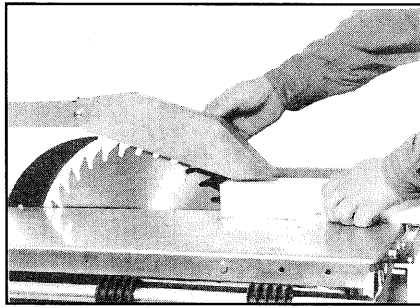

Set blade guard to thickness of work-piece.

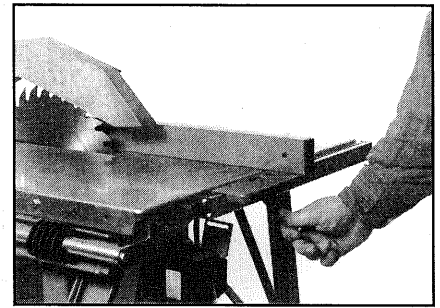

Set rip fence to desired width of cut and lock in position.

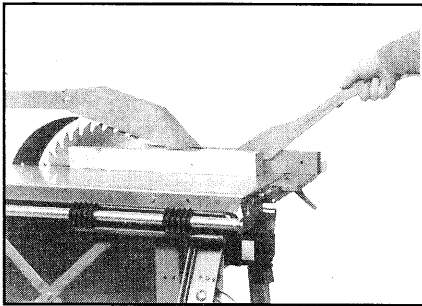

Important!

- Have blade at complete standstill before making adjustments - Disconnect machine from power before setting riving knife
- If width of cut is less than 120mm-4 1/2" always use a push stick to feed the work

10.2 Through Cross/Mitre Cuts

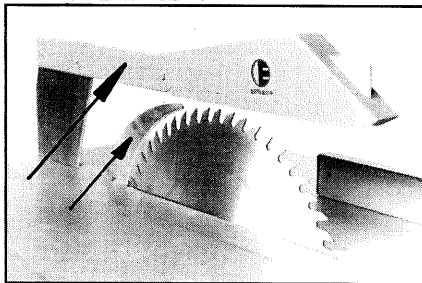

A - Have riving knife and blade guard in place - danger of injury.

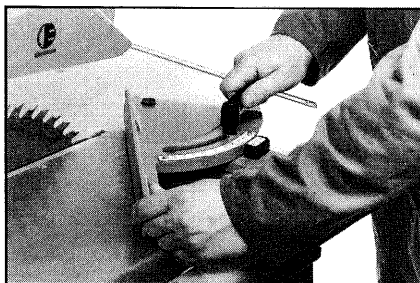

B - Swing mitre fence onto table and set to required angle

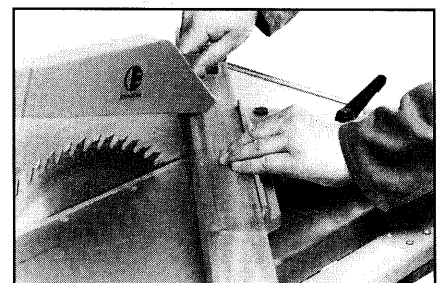

C - Pull mitre fence back and place work against it.
- Start machine

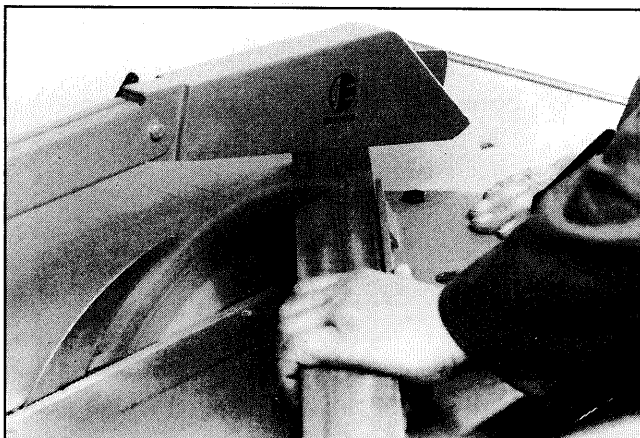

D - Push mitre and work forward to feed into blade

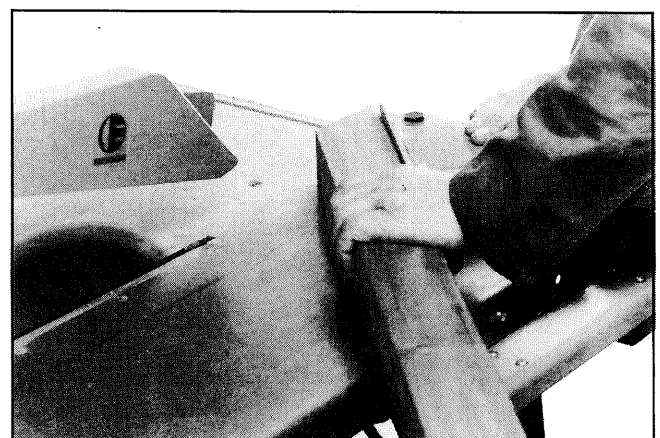

E - When cut is completed pull back both mitre fence and work

10.3 Cutting Wedges

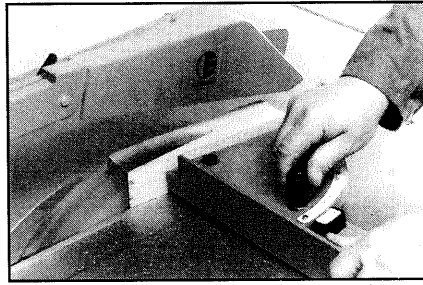
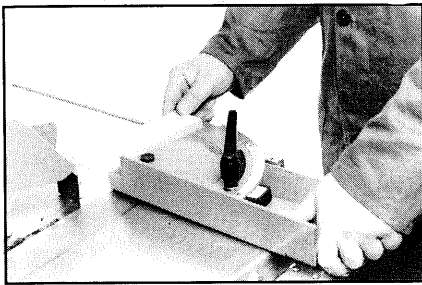

A - Place work firmly into wedge cutting jig and set to desired angle.

- Start machine

B - Push mitre fence forward to feed work into blade.

When cut is complete pull mitre fence back.

11.0 Saw Dust Collection (optional accessory)

- If this machine is operated in enclosed spaces it must be connected to a saw dust collection device.
- The dust collection device must have a minimum air flow rate of 20 m/sec.
- Connection to dust collector with 100 mm/4" diameter flexible suction hose.

12.0 Crane Lifting

For crane lifting swing both lifting eyes, attached to table, upwards.

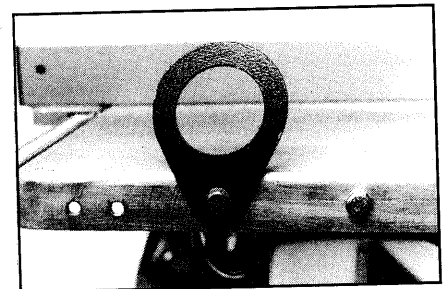

13.0 Safety Rules

As with all power tools there is a certain amount of hazard involved with the operator and his use of the machine. Using the machine with the respect and caution demanded as far as safety precautions are concerned will considerably lessen the possibility of personal injury. If, however, normal safety precautions are overlooked or completely ignored, personal injury to the operator can develop.

1. FOR YOUR OWN SAFETY; READ AND UNDERSTAND INSTRUCTION MANUAL BEFORE OPERATING THE SAW: Learn the saw's applications as well as the specific hazards peculiar to it.
2. KEEP GUARDS IN PLACE and in working order.
3. REMOVE ALL ADJUSTING KEYS AND WRENCHES: Form habit of checking to see that all keys and adjusting wrenches are removed from tool before switching it "ON".
4. ALWAYS USE SAW BLADE GUARD AND RIVING KNIFE for every operation for which they can be used, including through sawing. Through sawing operations are those when the blade cuts completely through the work piece as in ripping or cross cutting.
5. ALWAYS HOLD WORK FIRMLY AGAINST RIFENCE OR MITRE FENCE.
6. USE PUSH-STICK if distance between blade and rip fence is less than 120mm/5".
7. NEVER PERFORM ANY OPERATION "FREE-HAND".
8. NEVER REACH BEHIND, OVER OR UNDER THE CUTTING TOOL WITH EITHER HAND FOR ANY REASON. Keep hands away from saw blade; do not reach into area 120mm left and right of saw blade.
9. DIRECTION OF FEED: Feed work into saw blade against direction of rotation only.
10. AVOID KICKBACKS (work thrown back at you) by keeping the rip fence parallel to the blade, keeping riving knife and guards in place and operating, by not releasing work before it is pushed all the way past the saw blade, and by not ripping stock that is twisted or warped or does not have a straight edge to guide along the fence.

13.1 Problems

- If saw blade is stalled by waste, or the discharge port of the chip case clogged, switch machine off and let blade come to a complete standstill before attempting to remove obstruction.
- Switch motor off immediately if blade has stalled. A dull blade is most often the cause for what appears to be a loss of power of the motor.
- An extremely dull blade leaves burn marks in the kerf. Replace or sharpen at once.
- After a power failure the machine has to be switched on again.

14.0 Care and Maintenance

- Always disconnect from power before servicing. Do not rely on switch alone.
- This machine requires very little maintenance
- When changing the saw blade apply a light coat of oil to the arbor bolt.
- Regularly apply a light coat of oil to the mitre fence guide rod.

14.1 Tool Maintenance

Residue resin built-up on the saw blade(s) should be removed regularly. Immerse blade in a sodium carbonate solution or in paraffin/kerosene or mineral turpentine for 24 hours. The residue resin is then easily wiped off with a rag.

15.0 Wiring Diagrams

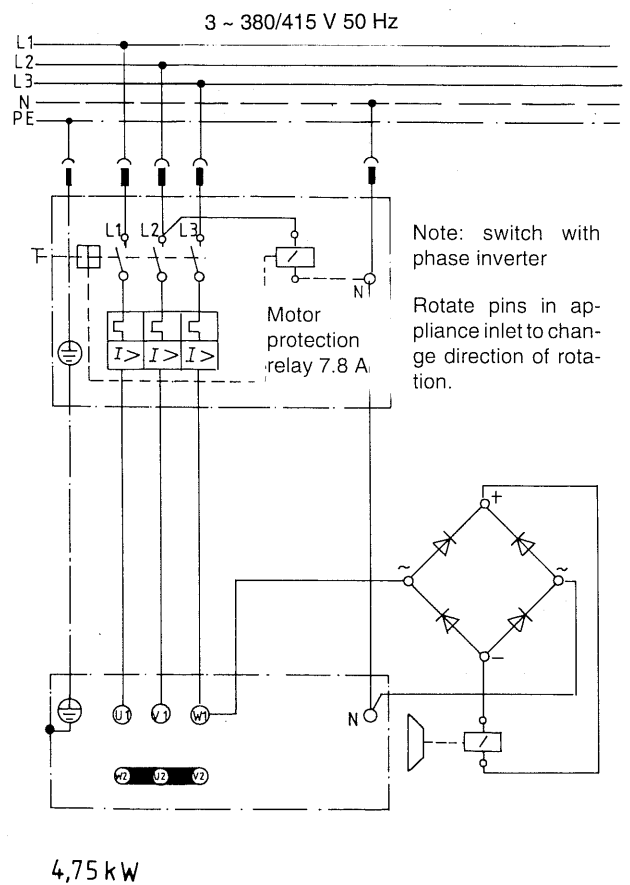
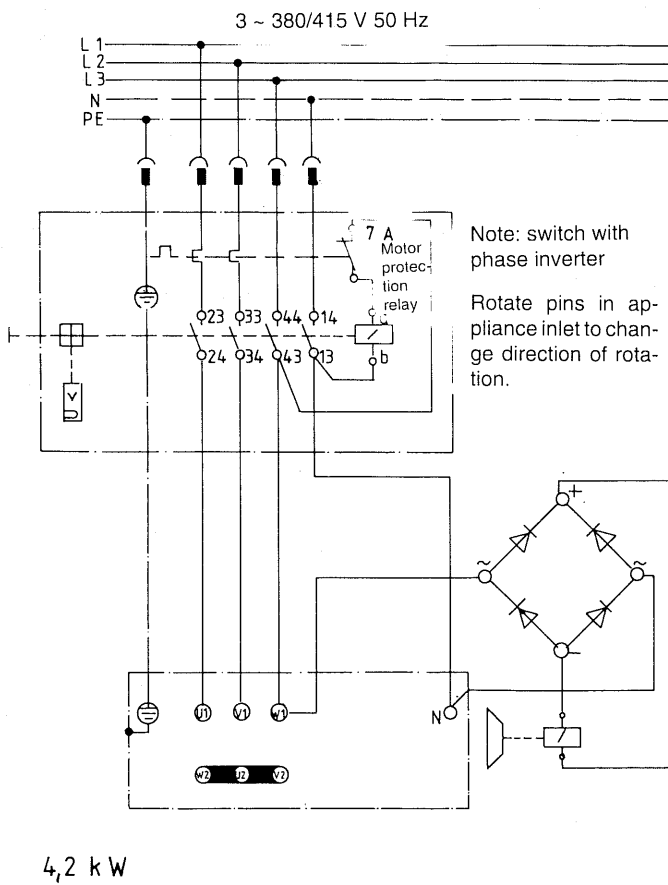
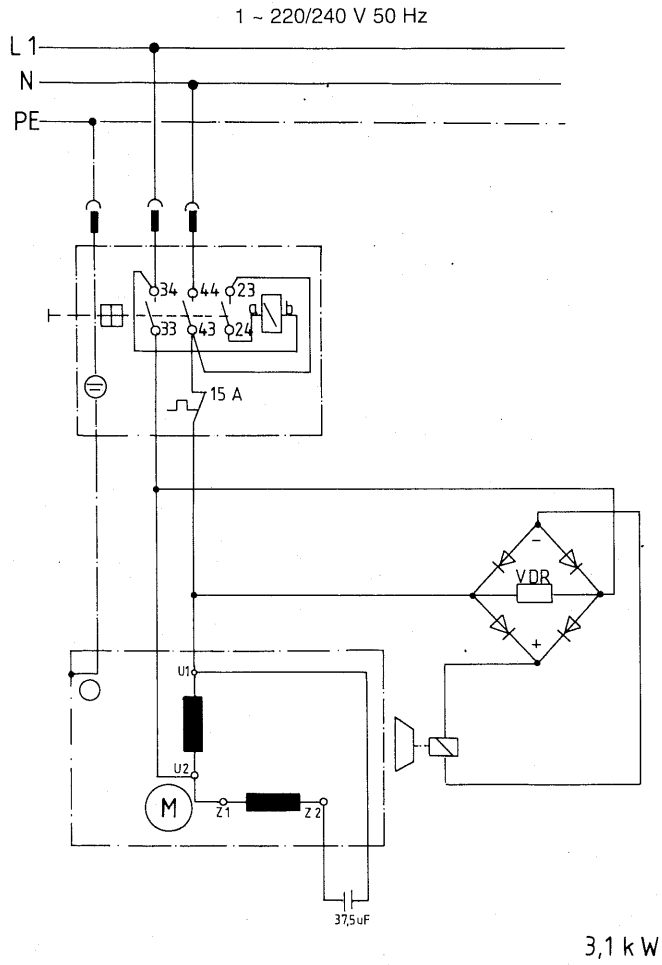

16.0 Spare Parts List Site Saws BKS Serial-no. 1001

Pos.	Description	Dimension	DIN	Stock-no.
1	Table top	1000x665		138 220 6343
2	Table insert	549.5		139 320 5551
3	Support strut			139 320 5035
4	Guard support bracket			139 220 5108
15	Rip fence BKH/BKS			201 020 0914
16	Parallel pin	Ø 10x40	7	650 010 7713
17	Cam-lock lever			239 020 5484
18	Clamping bracket			139 220 5620
19	Extrusion, rip fence guide			139 320 5560
20	Extrusion end plate			149 209 1649
21	Guide extrusion scale, metric	13x524		114 220 5714
22	Mitre fence carrier			201 020 0922
23	Guide bush, mitre fence carrier			239 120 5283
24	Mitre fence segment			139 020 5739
25	Glide piece, mitre fence			101 001 7587
26	Mitre scale			111 020 5593
27	Carrier, vernier scale			239 120 5615
28	Vernier scale			111 020 5607
30	Riving knife carrier			238 007 5353
31	Riving knife	50x3	38820	139 220 6163
32	Pressure plate, riving knife			138 206 8943
37	Gusset plate			139 220 5116
38	Guard support plate			149 210 5062
39	Blade guard carrier			139 220 5434
40	Blade guard BKH/BKS			239 120 6204
42	Push stick BK			139 420 1630
43	Combination wrench	SW 46-30-19-13		149 210 2829
44	Lifting eye			149 210 3230
45	Guide rod, mitre fence			149 510 2528
46	Guide rod bracket			149 210 5054
47	Motor flange BK	Ø 100/30		139 020 5208
48	Counter flange BK	Ø 100		239 020 5247
49	Switch plate			133 203 6064
50	Saw blade, 36 pointed teeth	Ø 450x2.5x30		091 000 5901
50	Saw blade, 32 pointed teeth	Ø 400x2.2x30		091 000 5910
51	Leg BK			201 020 0965
52	Strut BK	703		139 220 5051
53	Diagonal strut, long BK	830		139 220 5272
54	Diagonal strut, short BK	591		139 220 5410
59	Arbor bolt BK	M12x1.5x40 L.H.		610 308 5479
65	Fitting bolt	SW 19x42		139 520 5400
66	Pressure spring, lifting eye	Rdi 9x20		705 120 5663
67	Bolt	M8		139 520 5516
68	Chip case BKS			138 220 6319
69	Motor support bracket, rear			138 220 6335
70	Motor support bracket, front			138 220 6300
71	Motor plate			138 220 6297
72	Mounting plate			138 220 6289
73	Riving knife carrier bracket			138 220 6270
74	Chip case lid			138 220 6327
75	Hexagon socket head screw	M8x30	912	612 100 0855
81	Countersunk head tapping screw	4.2x13	7982	617 400 1942
82	Rsd. countersunk head tapping screw	4.8x13	7981	617 201 5687
83	Rsd. countersunk head tapping screw	4.8x16	7981	617 200 1830
85	Rsd. countersunk head tapping screw	4.8x22	7981	617 200 1848
87	Countersunk head screw	M8x16	965	613 100 9460
88	Rsd. countersunk head tapping screw	2.9x6.5	7981	617 209 1014
89	Countersunk head screw	M6x16	965	613 104 7582
90	Hexagon head screw	M8x16	933	610 300 1178
91	Hexagon head screw	M8x20	933	610 300 1186
93	Hexagon head screw	M6x30	933	610 301 9921
94	Hexagon head bolt with shank	M6x16	933	610 301 5675

Pos.	Description	Dimension	DIN	Stock-no.
96	Hexagon head bolt with shank	M8x35	931	610 203 1260
97	Hexagon head screw	M6x35	931	610 208 2751
99	Carriage bolt	M8x25	603	611 000 0640
100	Carriage bolt	M10x30	603	611 009 1603
101	Carriage bolt	M10x25	603	611 008 5743
102	Carriage bolt	M6x45	603	611 000 0624
103	Carriage bolt	M12x30	603	611 000 0691
104	Washer	Ø 6.4	125	630 001 6365
105	Washer	Ø 8.4	125	630 001 6322
107	Washer	Ø 10.5	125	630 003 4215
109	Torque type hexagon nut	M6	985	620 200 2291
110	Torque type hexagon nut	M8	985	620 200 2305
113	Wave spring washer	B12	137	630 208 5941
114	Hexagon socket set screw w/flat point	M8x20	913	616 102 9309
115	Hexagon thin nut	M8	439	620 502 9131
121	Starlock with cap	Rd 10mm		701 610 7721
123	Plug	60x25		139 101 9971
124	Hexagon head bolt	M8x90	601	610 102 2046
125	Ratched lever, female	M10		700 607 3730
126	Hexagon nut	M6	934	620 000 2219
128	Starknob, female	Rd 63 x M10		700 007 4122
129	Hexagon nut with washer	M12		620 900 2432
131	Spacer bush	Di 6x9		644 205 9304
132	Clamp			824 205 1328
133	Ratched lever, female	M6		700 607 2385
134	Thin parallel key	6x6x36	6885	6721 019 738
135	Motor BKS 4.75 DNB			101 001 6742
135	Motor BKS 4.2 DNB			101 001 6769
135	Motor BKS 3.1 WNB			101 001 6777
136	Switch BKS 4.75 DN			813 203 6137
136	Switch BKS 4.2 DN			813 200 1589
136	Switch BKS 3.1 WN			813 108 4839
137	Motorbrake ass'y, small			805 504 6132
138	Rectifier for motor 3.1 WNB			101 000 1150
	Rectifier for motor 4,2 DNB			101 000 1141
	Rectifier for motor 4,75 DNB			101 000 1133
150	Assembly/Operating instructions			115 107 8059

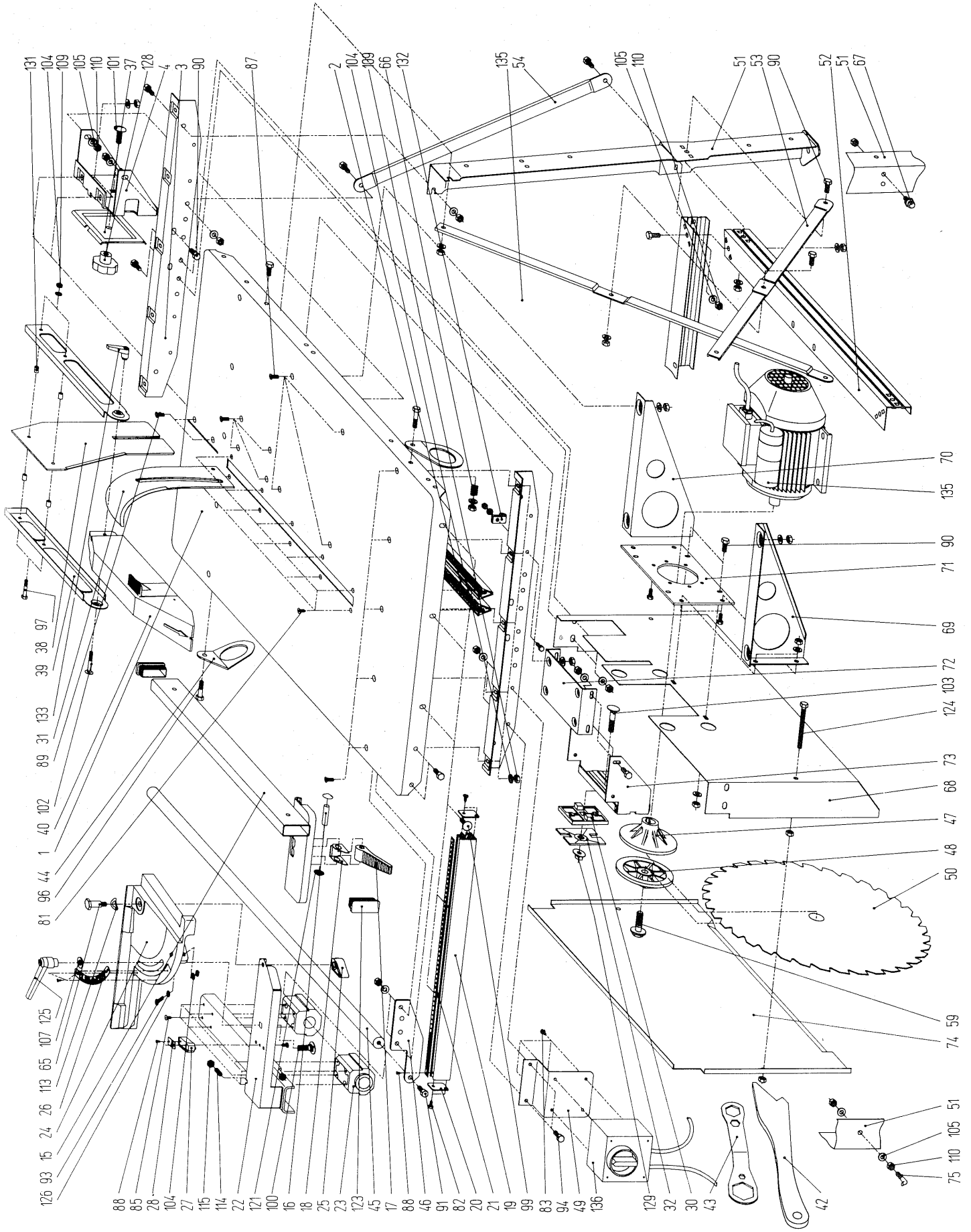

126 93 15 24 26 113 65 107 125 81 96 44 1 40 102 89 31 133 39 38 97

88 85 28 104 27 115 114 22 121 100 16 18 25 23 123 45 17 88 46 91 82 20 21 19 99 83 94 49 136

129 32 30 43 129 32 30 43

105 110 51 53 90 52 51 67 135 54 105 110 51 53 90 52 51 67

129 32 30 43 129 32 30 43

129 32 30 43 129 32 30 43

129 32 30 43 129 32 30 43

129 32 30 43 129 32 30 43

129 32 30 43 129 32 30 43

129 32 30 43 129 32 30 43

ELEKTRA BECKUM

The Complete Range- From A Single Source

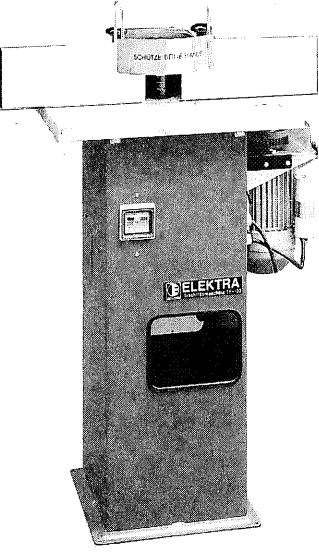
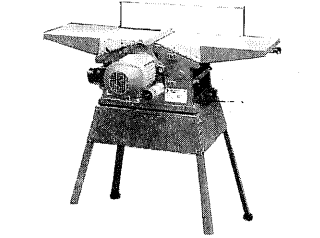
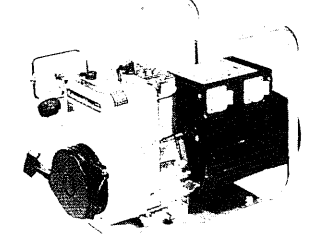
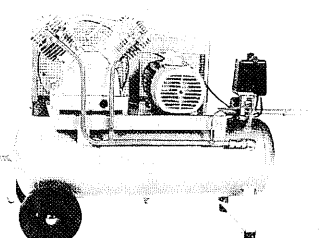
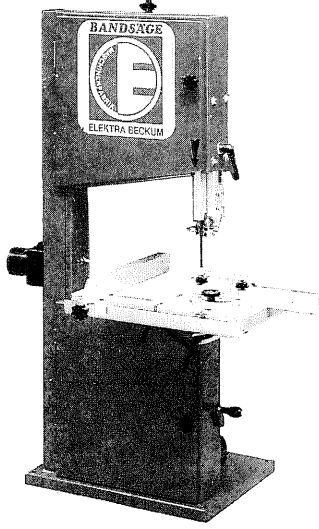
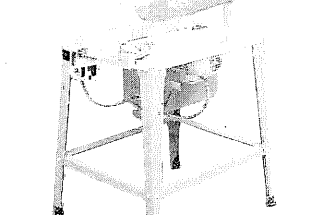
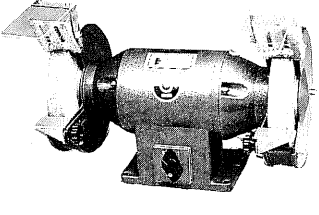
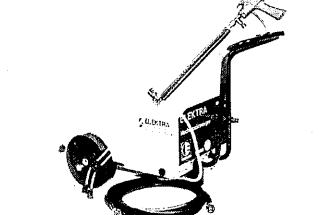
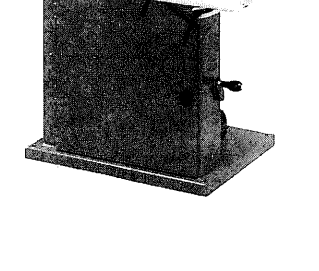
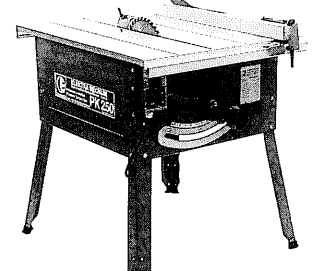
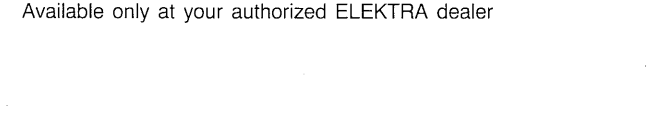
 <p>Spindle Moulders</p>	 <p>Planer/Thicknessers</p>	 <p>Generating Sets from 1,5 - 9 kVA</p>	 <p>Compressors from DIY to industrial</p>
 <p>Band Saws</p>	 <p>Wood Turning Lathes</p>	 <p>Welding Transformers MIG Welding Machines Plasma Cutters</p>	 <p>Water Pumps</p>
 <p>Precision Circular Saws</p>	 <p>Circular Saws Site Saws</p>	 <p>Double Bench Grinders High Pressure Cleaners</p> <p>Available only at your authorized ELEKTRA dealer</p>	

We reserve the right to change specifications and design without prior notice and obligation to backfit or supply backfit parts or components.